

LIFE MARINA PLAN PLUS PROJECT: SUSTAINABLE MARINE AND COASTAL SEABED MANAGEMENT



In June 2019, the research team of the LIFE MARINAPLAN PLUS project began operating the first-of-a-kind demonstration plant installation at the harbour entrance of Marina di Cervia (Italy). Fulfilling the project's objective to apply at industrial scale a reliable technology for the sustainable management of sediment in marine infrastructures, this technology prevents harbour silting through the use of submerged devices called 'ejectors' installed on the seabed.

The main objective of the ejectors plant installed in Marina di Cervia is to guarantee navigability at the harbour inlet while in operation.

The research project entitled 'LIFE MARINAPLAN PLUS: Reliable and innovative technology for the realisation of a sustainable marine and coastal seabed management plan', began in October 2016 and was completed in December 2020. Funded by the European Commission within the framework of the LIFE programme and co-funded by the Executive Agency for Small and Medium-sized Enterprises (EASME), the project was coordinated by the Italian company Trevi. A world leader in subsoil engineering, Trevi coordinated the research team that included the participation of three partners: the Municipality of Cervia (Italy), that played the role of technology end-user; the University of Bologna, responsible for the impact monitoring of the installation; and the International Council of Marine Industry Associations (ICOMIA) that acted as main dissemination and communication contributor.

The project team received EUR 1.45 million to design, realise, operate and monitor the first-of-a-kind demonstration plant installation (from here on referred to as 'the ejectors plant') at industrial scale of an innovative solution for the sustainable management of sediment in marine infrastructures. The ejectors plant operated from June 2019 to September 2020 and was able to guarantee navigability of Marina di Cervia's harbour

entrance for the whole period. This article presents the preliminary assessment of the ejectors plant results after 15 months of continuous operation and monitoring.

The need to remove deposited material from water basins is a common feature shared by many ports, harbours and waterways, and has been since the earliest settlements along coasts and rivers. Normally, the most widely used solution to remove sediment deposits is dredging. Dredging is a well-known, reliable and diffused technology. Nevertheless, in specific conditions (i.e. smaller marinas and channels), dredging in shallow water requires scaled technologies that are less productive and more expensive than standard configuration.

While dredging is able to restore the desired water depth, it is not without impact on sedimentation causes and therefore cannot guarantee avoiding sedimentation over time. Furthermore, dredging operations can often interfere with navigation and other nautical activities, and imply potential environmental impacts for the marine ecosystem: modifying marine habitat related organisms and disturbing contaminants already present in the seabed. Therefore, maintenance dredging operations often become too expensive and/or are not allowed by normative framework due to the related environmental impact.

Description of the ejectors plant

Cervia is a municipality of ~30,000 inhabitants, located along the Adriatic Sea in the Emilia-Romagna region. Marina di Cervia is located on the north-east side of the old harbour (Figure 1B), reserved for recreational craft, consisting of a dock with eight piers. The marina has a capacity of 300 boats with a maximum length of 22 m. The harbour is affected by a cyclic problem of inlet sedimentation. The technological solutions adopted until now, including seasonal dredging and/or sand underwater resuspension by boat propellers, as well as docks lengthening (completed in 2009), have not solved the sedimentation problem. In fact, from 2009–2015 ~EUR 1.3 million was spent on dredging and sediment handling with propellers (i.e. a mean yearly cost of EUR 185,000 (Pellegrini et al., 2020)).

The main objective of the ejectors plant installed in Marina di Cervia is to guarantee navigability at the harbour inlet while in operation. The plant consists of ten ejectors located at the harbour entrance as shown in Figure 2. The ejector (see Figure 3) is an open jet pump (i.e. without closed suction chamber and mixing throat) with a converging section instead of a diffuser and a series of nozzles positioned around the ejector. Each ejector is placed on the seabed and transfers momentum from a high-speed primary water jet flow to a secondary flow that is a mixture of water and the surrounding



FIGURE 1 Cervia's location in the northern Italian region of Emilia-Romagna (A) and aerial photo of the harbour study area (B).

sediment. The sediment-water mixture is then conveyed through a pipeline and discharged in an area where the sediment can be picked up again from the main water current (as in Cervia's application) or where it is not an obstacle for navigation. Based on preliminary tests carried out in 2017 (Pellegrini et al., 2020), with a primary water feeding flowrate of $\sim 27 \text{ m}^3/\text{h}$, a working pressure of $\sim 2.4 \text{ bar}$ and a discharge pipeline characterised by 60 metres in length, each ejector is able to convey a peak sand flowrate at the discharge pipeline of about $2 \text{ m}^3/\text{h}$ (whole discharge flowrate is $\sim 34 \text{ m}^3/\text{h}$) and a water pump power consumption of about 3.5 kW. The ejector works on a limited circular area created by the

pressurised water outgoing from the central and circular nozzles, whose diameter depends on the sediment characteristics such as, for example, the repose angle. By ejector integration in series and in parallel, it is possible to create or to maintain a seaway.

The technology is reliable as, generally speaking, jet pumps have been applied for coastal application since the 1970s. Regarding the ejectors technology, it was developed and tested in 2001 by the University of Bologna and the start-up Plant Engineering Srl. In 2005, the first experimental plant (Amati and Saccani, 2005) was realised and tested in the port of Riccione in

Italy. In 2012, a second experimental plant (Bianchini et al., 2014; Pellegrini and Saccani, 2017) was implemented in Marina di Portoverde in Italy. Both installations were realised at harbour entrances and designed to handle sand. A third experimental installation was established in 2018 in Cattolica in Italy, where for the first time the ejectors were applied in the management of silt and clay sediments and installed in a river channel (Pellegrini et al., 2020).

The Cervia ejectors plant also includes a fully automated and remotely accessible pumping station equipped with auto-purging filters. The Piping and Instrumentation Diagram (P&ID) of the pumping plant is schematically shown in Figure 4, where only one ejector line is drafted. There are two pumps, each one feeding five ejectors. Each pumping line has an auto-purging disk filter: the auto-purging cycle is activated once the pressure drop in the filter reaches a certain level. The total pumped water flowrate is controlled by an inverter, while the flowrate for each ejector feeding pipeline is balanced through electro valves. An air compressor can be used to inject compressed air in the line to easily

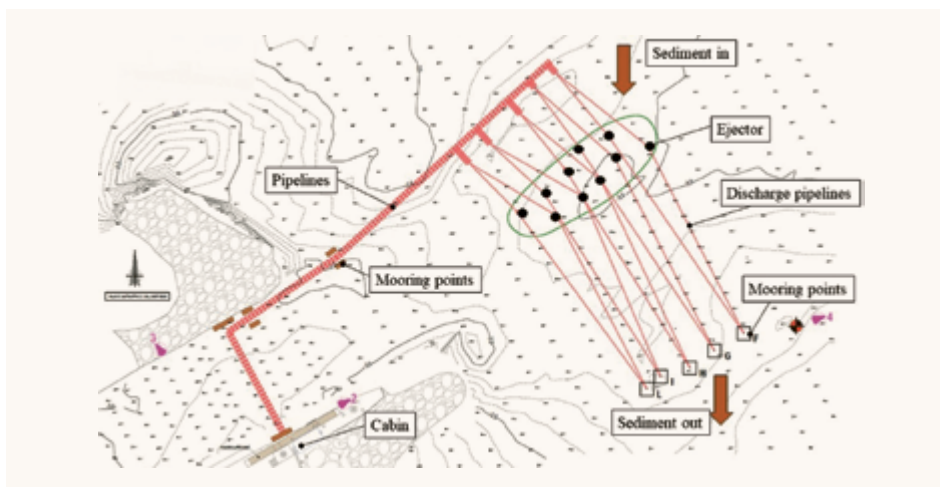

FIGURE 2 Location of ejectors in the Cervia plant.

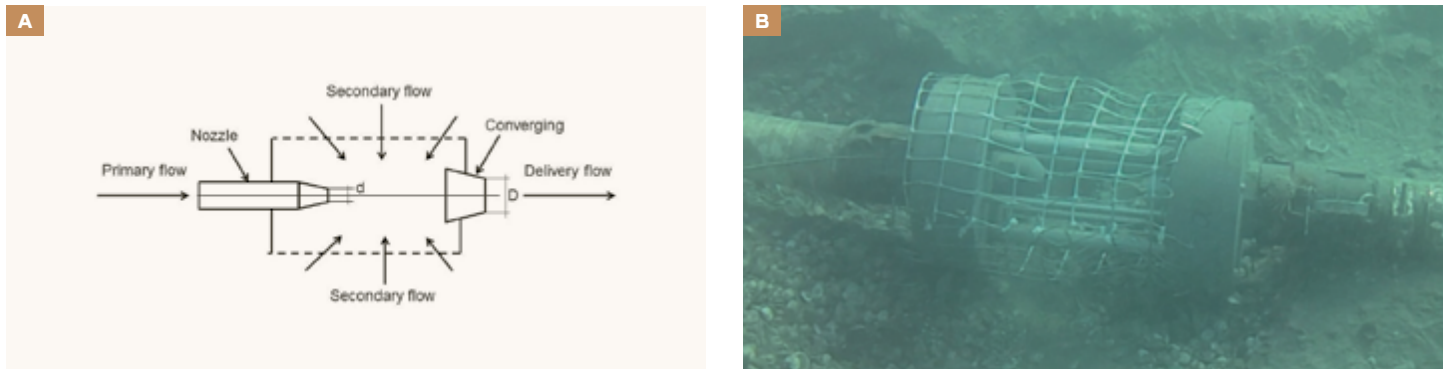

FIGURE 3
Diagram of the ejector (A) and underwater photo of the ejector in operation (B).

identify the position of the ejectors on the seabed. The total installed power is about 80 kW. A local meteorological station has been installed to relate plant operation with sea weather conditions.

The main novelty of the LIFE MARINAPLAN PLUS project is that the ejectors plant is designed and controlled to bypass the settling sediments, and not to remove them from the seabed. This feature is important in authorisation and permit procedures, since the mass balance in the area where the ejectors are installed can be considered as zero, and therefore the ejectors plant operation is not equated to maintenance dredging. Moreover, the continuous operation of the plant reduces the environmental impact to near zero, since the sediment management follows the rhythm of nature.

The monitoring plan

Bianchini et al. in 2018 already demonstrated through a literature review that a sand bypassing plant can be more economical than dredging, even if operation and maintenance costs are usually based on estimation more than on real data. One of the main objectives of the LIFE MARINAPLAN PLUS project was to measure the operation and maintenance costs over a consistent period. The efficacy of the ejectors plant was monitored through bathymetries in the ejectors area, while the efficiency was assessed through power consumption analysis.

Environmental monitoring activities are fundamental in the LIFE MARINAPLAN PLUS project, since reliable data are crucial to:

- evaluate the impact of the ejectors plant on the marine environment;
- compare the impact of the ejectors plant with that of dredging activities; and
- design sustainable sediment management.

The environmental impact of sand bypassing systems has never been analysed in

detail (Bianchini et al., 2019). Therefore, another interesting novelty of the LIFE MARINAPLAN PLUS project is the assessment of the ejectors plant impacts on marine benthic and fish communities, due to both sediment reworking and possible noise production. Moreover, the environmental impacts of the realisation and operation of the ejectors plant, projected over 20 years of

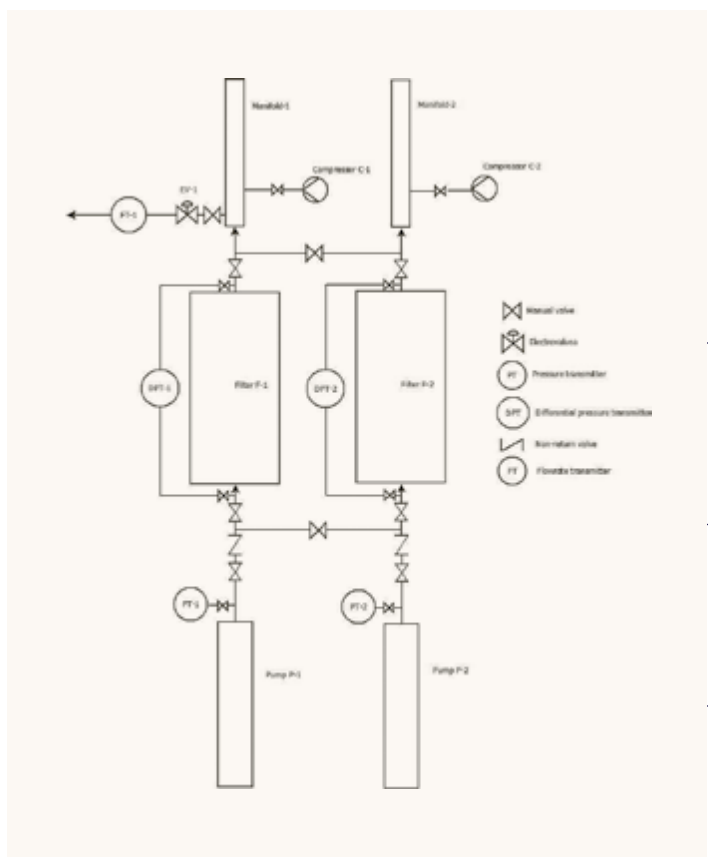

FIGURE 4
Piping and Instrumentation Diagram (P&ID) of the pumping plant.

PROJECT

operation, have been evaluated through the Life Cycle Assessment (LCA) approach.

Project results: navigability guaranteed

The Cervia ejectors plant operated continuously from June 2019 to September 2020, thus achieving the objective of the LIFE MARINAPLAN PLUS project; namely the monitoring of performance and impacts produced for a minimum period of 15 months operation. Table 1 summarises the five operating phases in which plant operation can be divided. In the first and second phases, the ejectors plant operated with a reduced load (25% and 50% respectively) and manual control: such a control strategy was necessary to limit pressure and power consumption, since some devices showed lower performances than the one declared by the suppliers. The plant then entered the third and fourth phases of operation, in which the full load of the plant was reached. In this period, however, a growing issue related to mussels (*Mytilus galloprovincialis*) fouling in the pipes and filters was detected. The performance of the ejectors plant was highly affected by fouling, since a reduced water flowrate was available for the ejectors and a higher pressure was needed, thus

dramatically increasing power consumption. Hence in the fifth phase only two ejectors were in operation.

Bathymetries have been carried out through a digital hydrographic ultrasound system with narrow emission cone, preliminary calibration and differential GPS Trimble positioning system; the resulting error is estimated as not exceeding 3 cm. Figure 5 shows the bathymetry before the ejectors plant installation: in Figure 5A there is a detailed colormap of water depth at the harbour entrance, while in Figure 5B specific areas with water depth more than 3 m, between 2–2.5 m and lower than 2 m are reported.

Despite the numerous problems encountered, which have been solved or for which a technical solution has been identified, the effectiveness of the ejectors plant is demonstrated by the ability of the plant to maintain a navigable channel with a minimum water depth of 2.5 m, measured with respect to the mean sea level leaving the harbour; a condition previously never reached at the beginning of the summer season without dredging operation. Figure 6 refers to the end of April 2020, i.e. after 10 months of continuous operation. Up until that date, the

effect of fouling was not critical in terms of effectiveness, even if efficiency was reduced.

The final bathymetry of the monitoring period (see Figure 7) was completed on 11 September 2020 and shows a critical sedimentation between the harbour entrance and the area of installation of the ejectors, which is not consistent enough to impede navigation. Nevertheless, it should be noted that only two ejectors were in operation from the end of July 2020 due to fouling limitations.

With regard to efficiency, the ejectors plant's consumption was higher than expected: as previously stated, starting from January 2020 until July 2020 (with a peak in June 2020), the uncontrolled growth of mussels in the pipes and filters considerably increased the pressure losses in the system, forcing the pumps to work with higher pressure, but with the same flow rate, compared to the operating conditions recorded in 2019. Various technical solutions alternative to chlorination are under evaluation to prevent the proliferation of organisms in the pipes, such as low-frequency electromagnetism. For this reason, based on the data collected in the first period of operation of the plant and the measured water flowrate for the whole monitoring period, it is

TABLE 1
Classification of operation phases of the ejectors plant in Cervia.

Demonstration plant operation regime	2019							2020									
	Jun	Jul	Aug	Sep	Oct	Nov	Dec	Jan	Feb	Mar	Apr	May	Jun	Jul	Aug	Sep	
Phase 1 Manual, partial load (25% of maximum)	■																
Phase 2 Manual, partial load (50% of maximum)						■											
Phase 3 Manual, full load									■								
Phase 4 Automatic - 10 ejectors													■				
Phase 5 Automatic - 2 ejectors																■	

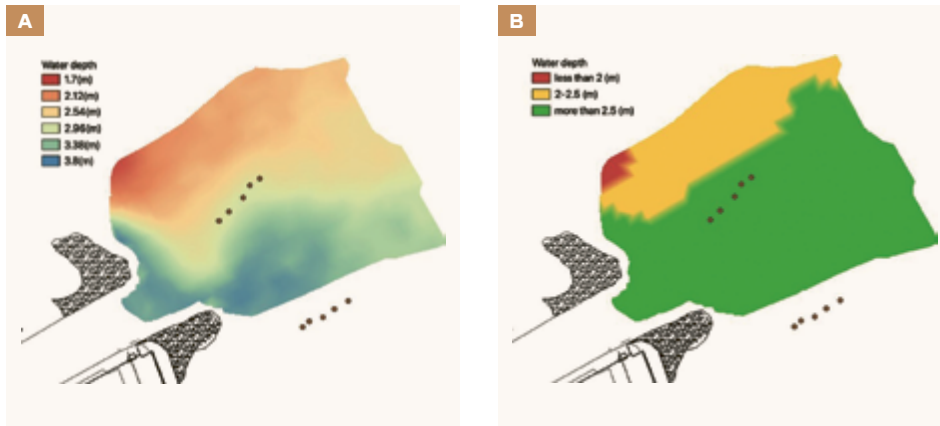

FIGURE 5
Colormap of water depth at the harbour entrance on 12 June 2019 (A) and of water depth for specific ranges (more than 3 m, between 2–2.5 m and lower than 2 m) on 12 June 2019 (B). The red circles indicate the GPS reference of the mooring points of inlet and outlet ejectors pipelines. The ejectors are installed between the inlet/outlet mooring points, as shown in Figure 2.

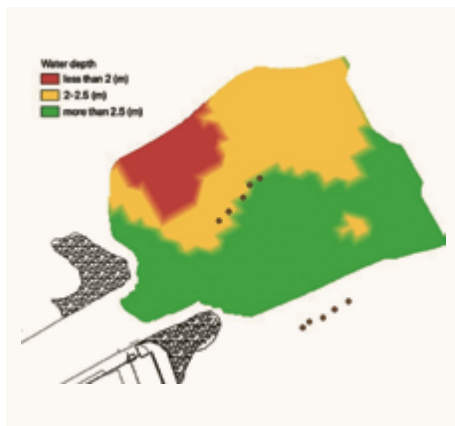

FIGURE 6
Colormap of water depth for specific ranges (more than 3 m, between 2–2.5 m and lower than 2 m) on 30 April 2020. The red circles indicate the GPS reference of the mooring points of inlet and outlet ejectors pipelines. The ejectors are installed between the inlet/outlet mooring points, as shown in Figure 2.



FIGURE 7
Colormap of water depth for specific ranges (more than 3.0 m, between 2.0–2.5 m and lower than 2.0 m) on 11 September 2020. The red circles indicates the GPS reference of the mooring points of inlet and outlet ejectors pipelines. The ejectors are installed between the inlet/outlet mooring points, as shown in Figure 2.

The results suggest an improvement in the ecological status of the marine ecosystem in the area affected by the plant.

possible to assess the average consumption of each ejector in normal conditions equal to 3 kW, i.e. an annual consumption for the ten ejectors of approximately 255,000 kWh/year.

Environmental impact assessment

While the effectiveness of the ejectors plant was already assessed in previous experimental installations, one of the main results of the LIFE MARINAPLAN PLUS project is related to the comprehensive monitoring of environmental impacts of plant operation, which includes:

- integrity of seabed sediments and communities;
- underwater noise;
- greenhouse gases (GHGs); and
- pollutant emissions through LCA.

Possible impacts of the ejectors plant on sediment characteristics, benthic and fish assemblages need to be assessed simultaneously at a variety of spatial scales, encompassing the full extent of the environmental variability of the area where the ejectors are positioned. Sampling sites are located in one putatively impacted location in front of the Marina di Cervia and in four control locations, placed 600 m and 1200 m north, and 600 m and 1200 m south of the impact location respectively (shown in Figure 8). Two sampling areas (~800 m² each), 20–30 m apart, were defined within each location. In particular, the impact location includes two distinct areas, the ejectors (I1) and the outlets (I2). Changes in time of the measured variables at each putatively impacted areas were compared to the whole range of control areas.

The use of the ejectors plant technology resulted in a reduction of the percentage of muddy fraction (Figure 9A) and of the organic matter content (Figure 9B) present in the sediment in the areas affected by the plant, compared to the initial values (samples taken in May 2018) conditioned by previous dredging, thus approaching the mean values observable throughout the study in the control areas. Species richness of marine macro-invertebrates (as shown in Figure 10), initially reduced in the impacted area near the harbour, probably as a result of previous repeated dredging, significantly increased 8 months after the ejectors plant began operation (i.e. February 2020), although still remained below the average for control sites. These results suggest an improvement in the

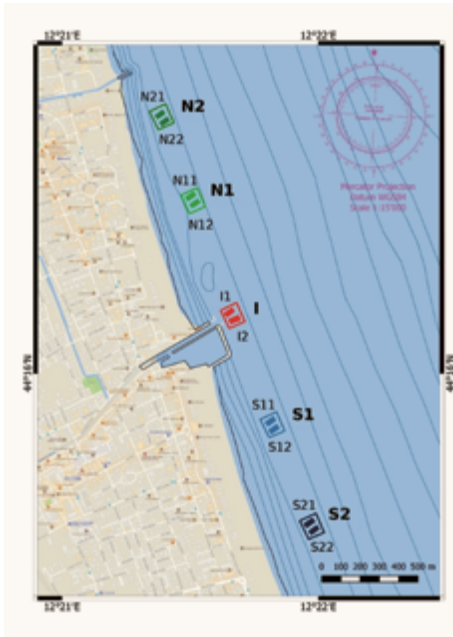

FIGURE 8

Map of sampling locations. Areas within location: N1 = North 600 m; N2 = North 1200 m; S1 = South 600 m; S2 = South 1200 m; and I = areas within location impact.

ecological status of the marine ecosystem in the area affected by the plant within less than one year from the start of plant operation.

The impact of the ejectors plant on underwater noise was assessed in September 2020. Since specific international standards do not currently exist for the measurement of underwater noise in a harbour environment, the document produced by the National Physical Laboratory (UK) has been taken into account (NPL, 2014). The acoustic measurements were carried out by a specialised operator and by using the SQ26-05 sensor, a pre-amplified hydrophone produced by Sensor Technology. The measurements were carried out on five sampling points (see Figure 11):

- nearest point from the hydraulic pumps (B1);
- 60 m from the hydraulic pumps (B2);
- ~200 m from the hydraulic pumps and 150 m from point B2 (B5);
- near the discharge point of the ejectors, approximately 50 meters away (M3); and
- ~185 m from point M3 (M4).

Furthermore, the measurements were carried out with the ejectors plant shut off and with the plant in operation in three different conditions: manual control at two different speeds of the centrifugal pumps, plus automatic control (variable speed of the centrifugal pumps).

The measurement sampling was conducted over 4 days (Friday to Monday) and performed during different time slots (day and afternoon). The measurement period, which included the weekend, was chosen to be able to observe the effect of tourism traffic, i.e. motor boats, with respect to the condition that occurs on working days (Friday and Mondays) in which traffic is more limited. While the assessment carried out in sampling points M3 and M4 relate to the impact on open marine environment, sampling points B1, B2 and B5 were measured to evaluate the impact of submersible centrifugal pumps for Marina di Cervia customers. All the acoustic data were analysed through MATLAB software. For each of the audio files, the average value of the Sound Pressure Level (SPL) in the frequency spectrum 12–20,000 Hz was calculated taking into account the gain level set for the recorder (M), for the pre-amplifier (G) and the sensitivity of the instrument (S), accordingly to equation 1:

$$SPL = 20 \log_{10} [\sqrt{P_x}] + M - G - S \quad [1]$$

where P_x corresponds to the ratio between the digital values of the audio file in 'wav' format (i.e. the uncompressed format that guarantees the preservation of a sound identical to the original without quality reduction in the analog-digital transformation that takes place inside the acoustic recorders) and the number of bits set for analog-digital conversion of the

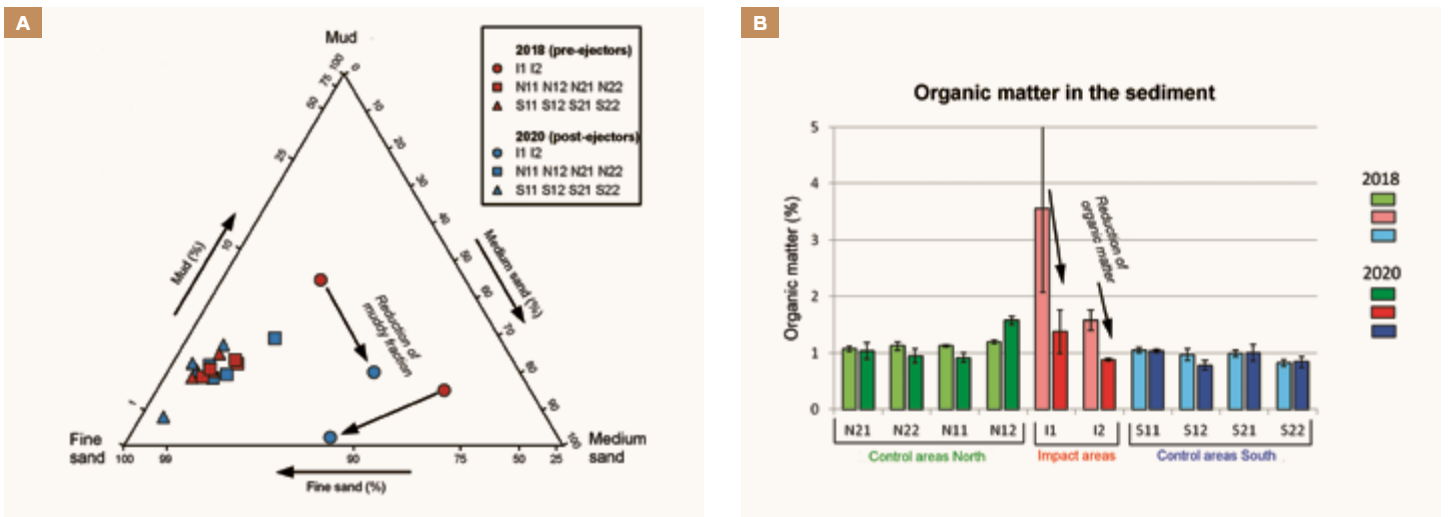

FIGURE 9

Proportions of the sediment granulometric fractions: medium sand $>250 \mu m$; fine sand $250-63 \mu m$; and mud $<63 \mu m$ (A) and percentage in weight of organic matter in the sediment (error bars based on standard error) (B).

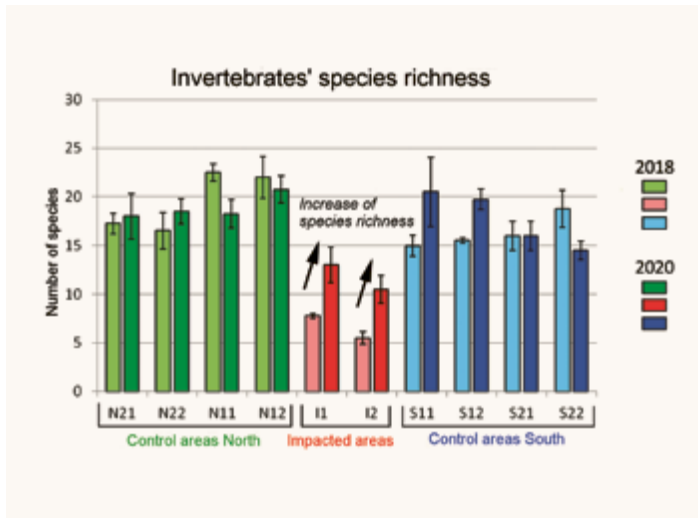

FIGURE 10

Mean number of macro-invertebrate species per sample in benthic communities (error bars based on standard error).



FIGURE 11

Locations of the five measurement points.

signal (16 bit). Particular attention was paid to the analysis of the average value of SPL in the operating frequencies of the hydraulic pumps (30–50 Hz). Where anomalies were found in the measured SPLs, the data were subjected to statistical tests, conducted with the aid of PAST advanced statistics software to investigate the presence of a statistically significant deviation from the average measured values.

The ejectors themselves had no impact on underwater noise level if compared with the 'natural' baseline, while only in the case of monitoring point B1 a difference was found between the noise levels in the recordings made with and without the hydraulic pumps in operation (see Figure 12). Nevertheless, the data were subjected to the Mann-Whitney statistical test for non-parametric distributions, to verify, in the presence of ordinal values from a continuous distribution, if two statistical samples come from the same population. The results obtained indicate that the difference between the measurements made with the inactive hydraulic pumps ('off' in Figure 12) compared with the measurements made with the hydraulic pumps 'on' and at different operating status (max, min and automatic control in day #1 and day #2) is not statistically significant ($p = 0.12$, which is greater than the significance value of 0.05) and therefore not attributable solely to the activity of hydraulic

pumps. The conclusion is that from the analysis of the acoustic data, it emerged that in the harbour environment the impact of ejectors and hydraulic pumps to underwater noise level is insignificant.

Finally, the impact of the Cervia ejectors plant construction and operation on GHGs and pollutant emissions was assessed through LCA. The choice of system boundaries considered only emissions related to raw materials processing and plant operation phases. The other phases of plant construction (components manufacturing, transport and assembly) as well as decommissioning phase was not included since their contribution was considered as negligible. This hypothesis is consistent with available literature data on LCA of pumping station (Jocanovic et al., 2019), which is comparable in terms of components and expected life with the ejectors plant. The Life Cycle Inventory (LCI) was performed on the basis of:

- bill of materials (BOM) analysis, to identify/classify the components used for the realisation of the ejectors plant;
- energy consumption in operation; and
- components substitution for damaging and/or wear over the years.

The estimated life of the ejectors plant is 20 years. To take into consideration the optimisation potential of energy consumption

that is estimated on the basis of the 15 months monitoring of plant operation in Cervia, the LCA analysis considers two different scenarios for energy consumption:

- the energy consumption measured during the LIFE MARINAPLAN PLUS project, which is about 530,000 kWh/year; and
- the energy consumption optimised, which is estimated at ~147,000 kWh/year.

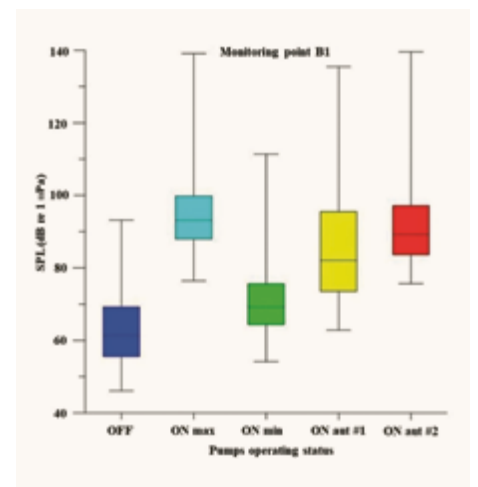

FIGURE 12

Box-plot of the average SPL values (on the ordinates) for the different operating states of the hydraulic pumps (on the abscissas).

TABLE 2

Impacts of the ejectors plant in the two different scenarios by considering the functional unit. NMVOC = non-methane volatile organic compounds.

		SCENARIO #1					
Boundary	Source	Environmental impact					
		CO ₂ (kg)	CO (kg)	SO ₂ (kg)	NO _x (kg)	PM2.5 (kg)	NMVOC (kg)
Construction	Materials	57,816	33.5	6.7	4.4	1.2	6.5
	Energy	3,498,000	-	-	-	-	-
Operation	Materials	5,202	0.06	0.01	0.0	0.0	0.28
	Total	3,561,018	33.6	6.7	4.4	1.2	6.8

		SCENARIO #2					
Boundary	Source	Environmental impact					
		CO ₂ (kg)	CO (kg)	SO ₂ (kg)	NO _x (kg)	PM2.5 (kg)	NMVOC (kg)
Construction	Materials	28,908	16.8	3.3	2.2	0.6	3.3
	Energy	970,200	-	-	-	-	-
Operation	Materials	2,601	0.03	0.01	0.00	0.00	0.14
	Total	1,001,709	16.8	3.3	2.2	0.6	3.4

The estimation of optimised energy consumption is based on the following considerations: the ejectors plant operated almost continuously, and by considering the hours of maintenance and the stop period registered during LIFE MARINAPLAN PLUS project implementation, it is possible to estimate that the ejectors plant worked approximately 8400 hour per year, which means a measured mean power consumption per ejector of 6.3 kW. Nevertheless, by considering the early operation period of the plant, which was not affected by fouling, it can be noticed that the mean power consumption per ejector could be ~3 kW, which is coherent with the yearly energy consumption estimated for the optimised scenario. Moreover, the results of monitoring actions highlighted how five ejectors instead of the ten installed should be enough to avoid sedimentation at the harbour inlet. Therefore, the final estimation

of energy consumption in an optimised configuration considers five ejectors with a mean power consumption of 3.5 kW. Operation strategy could be further optimised to reduce energy consumption by plant shut off in certain conditions, but such a strategy needs to be validated in the field.

Material consumption for components being damaged and/or worn has been included to also consider the impact of spare parts or component substitutions. The hypotheses are based on the manufacturers' datasheet and the monitoring of 15 months of operation of the ejectors plant in Cervia:

- Marine installation: substitution of 5 km of pipeline per year;
- Inverter: expected lifetime 10 years;
- Pump: expected lifetime 10 years; and
- Pipeline brackets (metallic): expected lifetime 10 years.

Table 1 summarises the impacts of the ejectors plant construction and operation referred to the functional unit and by considering the two different scenarios previously described. A further emission reduction could be reached if the ejectors plant would be powered by renewable energy.

The categories selected to describe the impacts caused by the emissions and the consumption of natural resources at midpoints are Global Warming Potential (GWP), fine particulate matter formation (PMFP), photochemical oxidant formation (EOPF and HOPF) and terrestrial acidification (TAP). All categories have been assessed accordingly to ReCiPe 2016 (Huijbregts et al., 2016). Figure 13 shows the results of the LCA.

Economic assessment

The primary elements of the economic assessment are BOM analysis (purchasing costs of all the components used for the realisation of the ejectors plant), construction site work journal (manpower costs for installation and commissioning

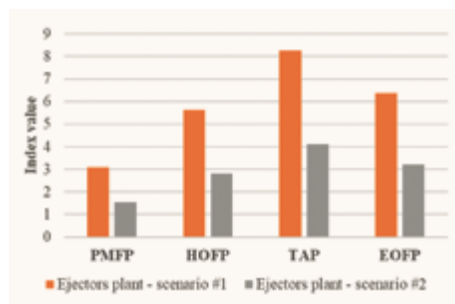
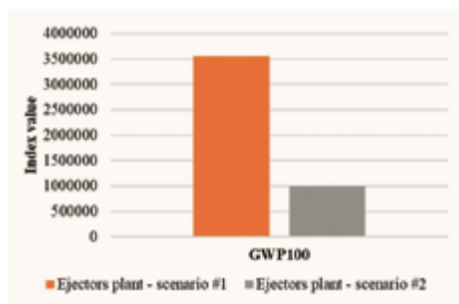

FIGURE 13

Comparison of midpoint characterisation between the two scenarios.

The operation of the plant is expected to reduce sediment management costs for the Municipality of Cervia with a near-zero impact on marine environment.

and number of hours), energy consumption in operation, costs for component substitutions for damage and/or wear over the years, and manpower for maintenance activities.

By considering the ejectors plant construction, some equipment has been added, in particular automatic anti-fouling system to prevent pipelines and filters clogging. Moreover, based on experience gained from the project, the divers and workers costs have been recalculated by considering the management optimisation that could be reached by having better coordination between Trevi's purchasing department, Trevi's human resources department and subcontractors in the organisation of the construction site. The realisation of a five-ejector plant (optimised configuration) would require 25 days of onshore activities, plus 10 days of marine activities. To evaluate the benefits for the ejectors plant customer, i.e. the Municipality of Cervia, the selling price is estimated by adding Trevi's costs plus unexpected events, overheads and profit. The final result is a total cost for the municipality of EUR 520,000.

The costs related to the ejectors plant operation can be summarised in the following categories: energy consumption and maintenance (components/spare

parts cost and manpower). The cost of energy is ~about 0.21 €/kWh. Based on the ejectors plant monitoring activities and by considering maintenance optimisation that could be reached through i) the installation of an automatic anti-fouling system and ii) more robust and cost effective solutions for the marine installation; it is assumed that a single diver for 12 days per year plus one worker for 52 hours per year are enough to guarantee the ordinary maintenance of a five-ejector plant. Extraordinary maintenance, including substitution of spare parts and main components affected by wear (such as pumps or inverters), is calculated as a percentage (20%) of the whole yearly operation and ordinary maintenance cost. The final result is an operation and maintenance (ordinary and extraordinary) cost of about EUR 50,000 per year for the Municipality of Cervia.

Figure 14 shows the simple payback time for the municipality by considering two comparisons with dredging costs: a yearly cost of EUR 185,000 (coherent with historical data) and a yearly cost of EUR 115,000 calculated excluding dredging costs for beach nourishment. The investment in the technology provides a very competitive result, with a simple payback time of 4 years in the best scenario. Nevertheless, if a lesser advantage is considered for the municipality, i.e. operation and maintenance cost increasing of the ejectors and/or partial use of dredging equipment for extraordinary maintenance, the investment still gives an attractive result with 7 years of simple payback time.

Conclusions

The LIFE MARINAPLAN PLUS project tested and validated an innovative technology for sediment management in water infrastructure. The first application at industrial scale of the ejectors plant has been realised at the harbour entrance of Marina di Cervia (Italy) with promising results in terms of effectiveness, since the navigability of the harbour entrance was guaranteed for the whole operation period of 15 months. Some technical improvements are needed to limit fouling issues, optimise power consumption and maintenance activities. Nevertheless, the solutions to address all the issues that arose during the project have already been identified.

Trevi is now committed to the retrofitting of the ejectors plant, which should be converted to a five-ejector plant. Based on monitoring activities carried out during the project, the operation of the plant is expected to reduce sediment management costs for the Municipality of Cervia with a near-zero impact on marine environment (i.e. seabed integrity and underwater noise level) and limited impact on GHGs and pollutant emissions.

Trevi is also looking for industrial partners, including dredging companies, to develop business-to-business opportunities related to integration of sustainable and green technologies for ports, harbours and waterways, as well as in combination with dredging. In the latter case, the match between an ejectors plant and dredging would result in a win-win opportunity since dredgers can support plant operation for extraordinary maintenance dredging.

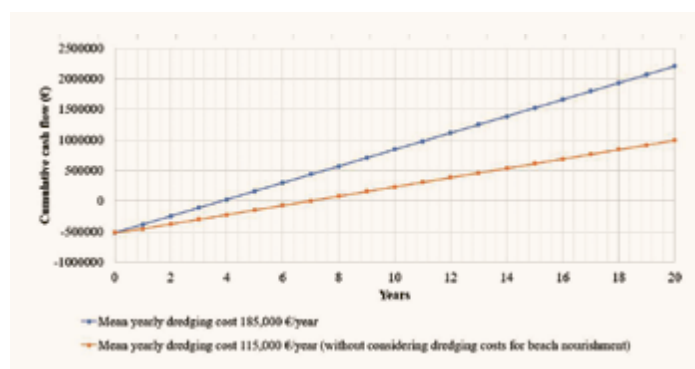

FIGURE 14 Simple payback time for the Municipality of Cervia.

Summary

The project team received EUR 1.45 million to design, realise, operate and monitor the first-of-a-kind demonstration plant installation at industrial scale of an innovative solution for the sustainable management of sediment in marine infrastructures. This article summarises the results of monitoring actions carried out at the harbour entrance of Marina di Cervia (Italy), where the ejectors plant was installed and operated from June 2019 to September 2020 within the framework of the EU funded project LIFE MARINAPLAN PLUS. The ejectors plant was designed to continuously remove the sediment that naturally settles in a certain area through the operation of the ejectors, which are submersible jet pumps. The final aim of the project is to combine continuous water depth maintenance at the harbour entrance with environmental and economic sustainability through a reduction of the impacts on marine environment produced by sediment management. LIFE MARINAPLAN PLUS project was coordinated by Trevi SpA, which realised and operated the ejectors plant, while Municipality of Cervia, University of Bologna and ICOMIA participated as partners.



Marco Pellegrini

Marco is assistant professor in Industrial Mechanical Plants at the University of Bologna. He joined the Department of Industrial Engineering in 2007 and has both research and teaching experience. Marco's research activities include sustainable sediment management, renewable energy generation, storage and distribution, and health and safety at work. He is author of more than 80 papers in peer-reviewed journals and relevant international conferences.



Giovanni Preda

Since 2009, Giovanni has worked as R&D Project Manager for Trevi Spa – a worldwide leader in engineering, specialising in foundations, restoration of dams, ports and jetties, tunnels, confinement of contaminated sites and restoration of monuments. His main focus is on the development of innovative technologies for sediment management and treatment, environmental dredging, reclamation of contaminated areas, waste management and soil improvement.



Barbara Mikac

Barbara is a marine ecologist and currently a research fellow at the Interdepartmental Research Centre for Environmental Sciences (CIRSA) of the University of Bologna. Her research is focused on diversity, structure, dynamics and ecology of benthic communities and natural and anthropogenic impacts on them, distribution and impacts of non-indigenous marine species and diversity and conservation of marine species and habitats. Specialised in ecology, systematic and taxonomy of polychaetous annelids, Barbara has described several species new to science.



Massimo Ponti

Massimo is a marine ecologist and associate professor at the Department of Biological, Geological and Environmental Sciences (BiGeA) of the University of Bologna. He is president of the Italian Association of Scientific Divers, a dive master instructor and vice president of Reef Check Italy, a non-profit association. His research ranges from temperate to tropical benthic ecology, mainly focusing on species diversity, habitat-species interactions, effects of human disturbances and climate change at community and population levels, and biodiversity conservation.



Cesare Saccani

Cesare is professor in Industrial Mechanical Plants at the University of Bologna, Department of Industrial Engineering. He has a decennial experience in multi-phase flow design, modelling and testing. Coordinator of the local unit in several international and national research projects, he is the author of over 110 papers on industrial mechanical plants topics and is the inventor of 10 patents.



Arash Aghakhani

Arash is a PhD student at the University of Bologna. He joined the 'Future Earth, climate change and societal challenges' programme in 2019. His focus is mainly on the low-carbon systems for climate change mitigation and adaptation, coastal erosion, sediment transport and renewable energies. Arash gained his Masters in environmental engineering at the University of Bologna.



Marco Abbiati

Marco is a professor at the Department of Cultural Heritage of the University of Bologna. Working in the fields of basic and applied marine ecology, environmental management and conservation, he has coordinated several research projects funded by the EU, ministries and private companies. Since 2020, Marco is Science Attaché at the Italian Embassy in Hanoi, Vietnam.



Marina Antonia Colangelo

Marina is a marine ecologist and senior researcher at the Department of Biological, Geological and Environmental Sciences (BiGeA) of the University of Bologna. Her research focuses on the ecology of meio and macrobenthic communities and their role in the subtidal and intertidal ecosystem of sandy coasts.

REFERENCES

- Amati G. and Saccani C. (2005) Experimental plant for sediment management in harbour areas. *Proceedings of the XXXII National Conference on Italian Plant Engineering*, 6–7 October, Rimini, Italy.
- Bianchini A., Pellegrini M. and Saccani C. (2014) Zero environmental impact plant for seabed maintenance. *Proceedings of the International Symposium on Sediment Management I2SM*, 17–19 September, Ferrara, Italy.
- Bianchini A., Cento F., Guzzini A., Pellegrini M. and Saccani C. (2019) Sediment management in coastal infrastructures: techno-economic and environmental impact assessment of alternative technologies to dredging. *Journal of Environmental Management*, 248. DOI: <https://doi.org/10.1016/j.jenvman.2019.109332>
- Huijbregts M.A.J., Steinmann Z.J.N., Elshout P.M.F., Stam G., Verones F. and Vieira M.D.M. (2016) ReCiPe 2016. A harmonized life cycle impact assessment method at midpoint and endpoint level. Report I: Characterization, National Institute for Public Health and the Environment.
- Jocanovic M., Agarski B., Karanovic V., Orosnjak M., Micunovic M.I., Ostojic G. and Stankovski S. (2019) LCA/LCC Model for Evaluation of Pump Units in Water Distribution Systems. *Symmetry*, 11. DOI: <https://doi.org/10.3390/sym11091181>
- NPL (2014) Good Practice Guide for Underwater Noise Measurement, *NPL Good Practice Guide No. 133*. ISSN: 1368-6550
- Pellegrini M. and Saccani C. (2017) Laboratory and field tests on photo-electric probes and ultrasonic Doppler flow switch for remote control of turbidity and flowrate of a water-sand mixture flow. *IOP Journal of Physics Conference Series*, 882:012008. DOI: <https://doi.org/10.1088/1742-6596/882/1/012008>
- Pellegrini M., Abbiati M., Bianchini A., Colangelo M., Guzzini A., Mikac B., Ponti M., Preda G., Saccani C. and Willemssen A. (2020) Sustainable sediment management in coastal infrastructures through an innovative technology: preliminary results of the MARINAPLAN PLUS LIFE project. *Journal of Soils and Sediments*, 20. DOI: <https://doi.org/10.1007/s11368-019-02546-6>
- Pellegrini M., Preda G. and Saccani C. (2020) Application of an innovative jet pump system for the sediment management in a port channel: techno-economic assessment based on experimental measurements. *Journal of Marine Science and Engineering*, 8. DOI: <https://doi.org/10.3390/jmse8090686>